

ROTATOR GR 16 S

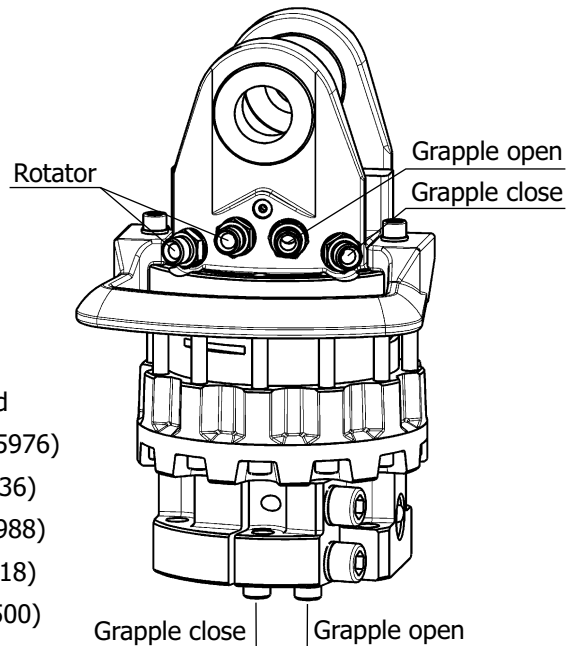
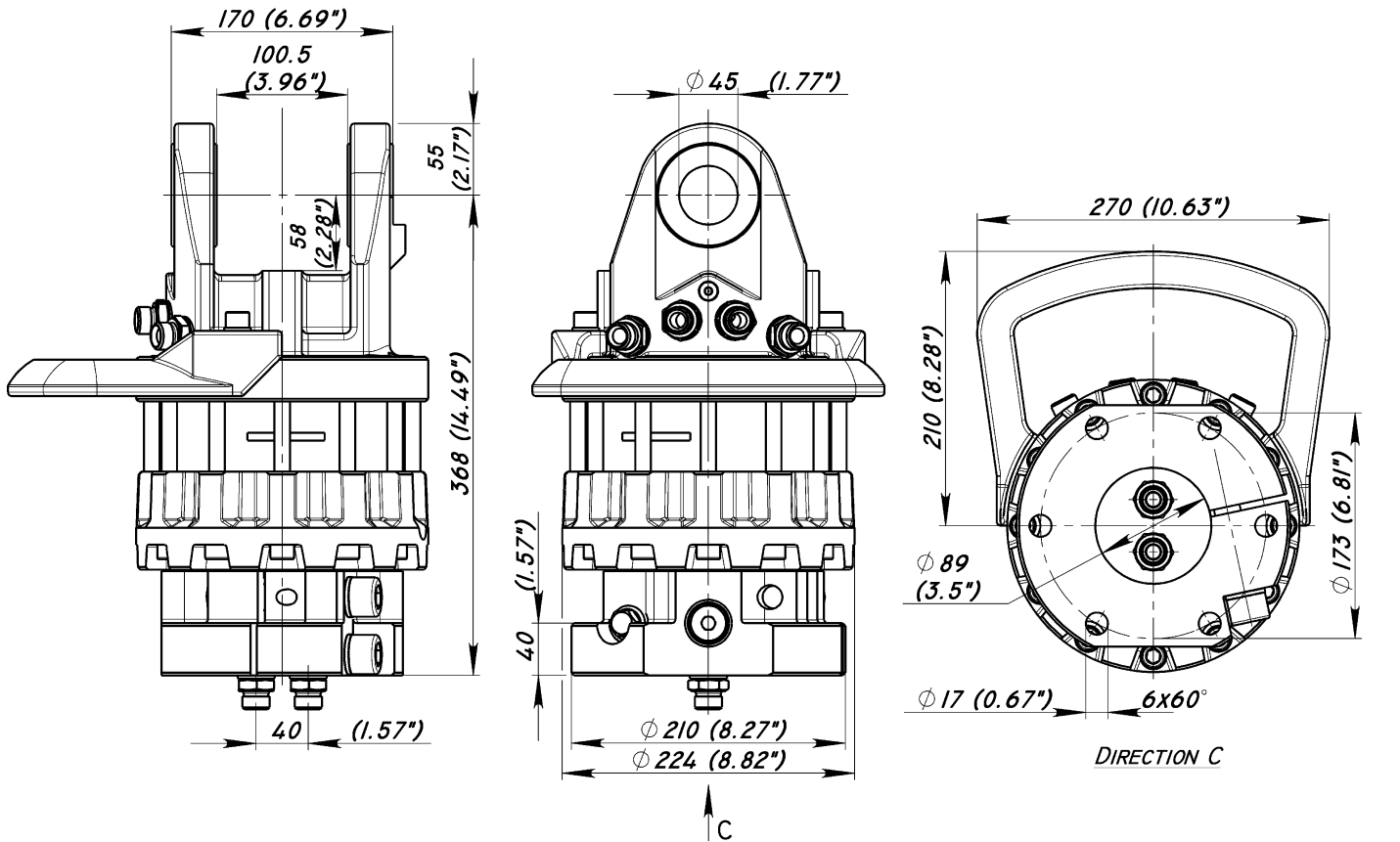

Technical data

Rotation	Unlimited
Max axial load static, KN (lbf)	+160 (35976) -90 (20236)
Max axial load dynamic, KN (lbf)	+80 (17988) -45 (10118)
Torque at 25MPa (3625psi), Nm (lb ft)	3400 (2500)
Rec oilflow, l/min (US gallon)	40 (10.6)
Weight, kg (lb)	71 (157)

Max working pressure:

Rotator	←R→	Max 25 MPa (3625 psi)
Grapple / Tool open	←G→	Max 30 MPa (4350 psi)
Grapple / Tool close	→G←	Max 30 MPa (4350 psi)

Connection:

G 1/2"
G 1/2"
G 1/2"

2005.01.06