

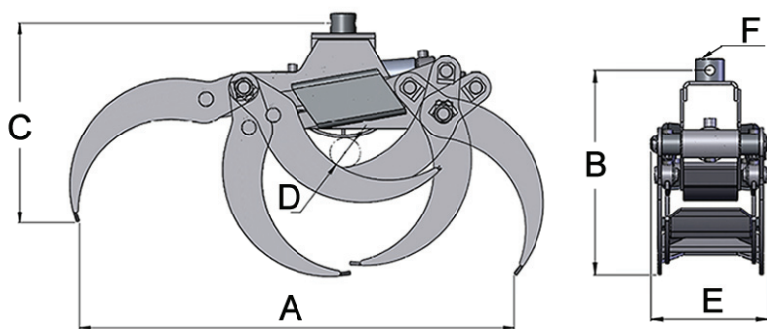









# TG 22-50



|   |       |
|---|-------|
| A | 1310  |
| B | 544   |
| C | 606   |
| D | 90    |
| E | 311   |
| F | 50/25 |

|   |  |  |  |   |  |  |   |  |
|---|--|--|--|---|--|--|---|--|
|  |  Kg |  tm |  m <sup>2</sup> |  Bar |  |  N° |  l/min |  kN |
| TG 22   | 98   | 3  | 0,22   | 200   | IVR 3  | 1  | 50  | 13,5   |

INTERMERCATO AB  
SE-272 93 TOMMARP  
Sweden

Tel +46 414 205 25  
Fax +46 414 205 60

[www.intermercato.com](http://www.intermercato.com)  
[info@intermercato.com](mailto:info@intermercato.com)