

## Inlet section

### Dimensional data and hydraulic circuit

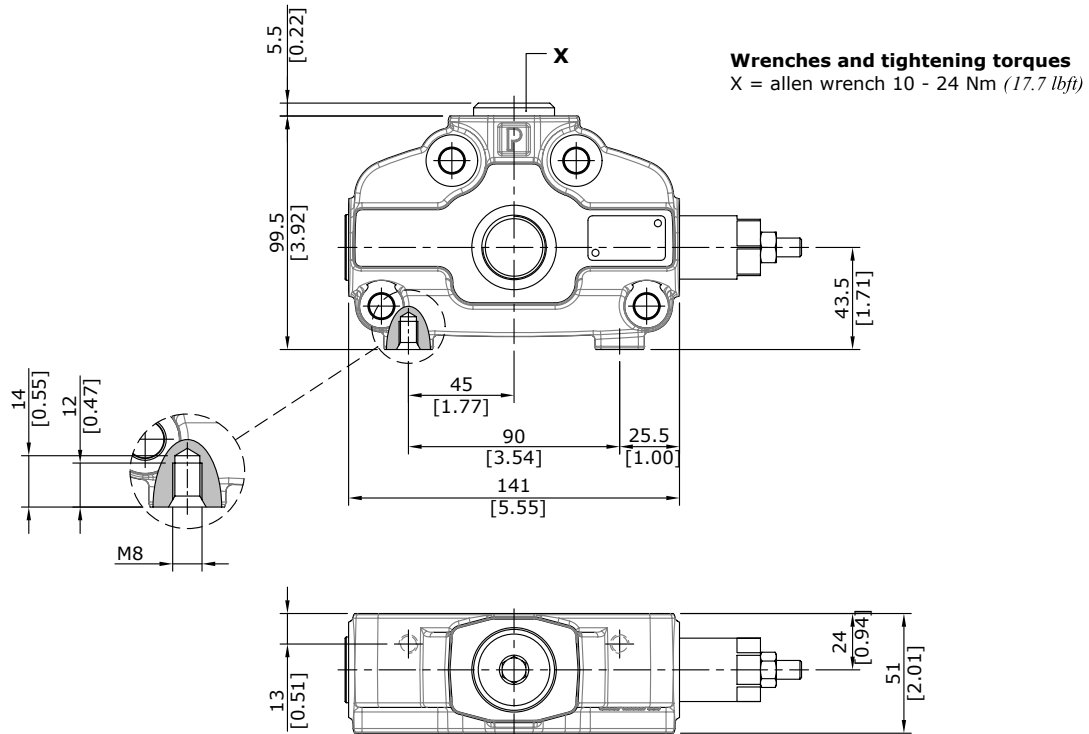

For left inlet directional valve, side port

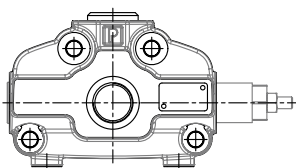
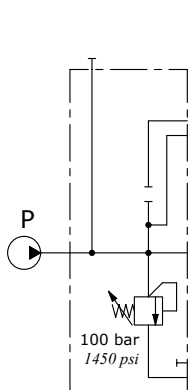

Description example:  
**AC(X-100)**

For left inlet directional valve, upper port

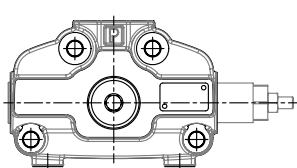
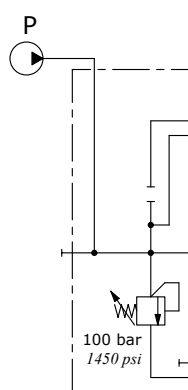

Description example:  
**AD(X-100)**

For right inlet directional valve, side port

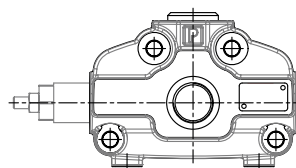
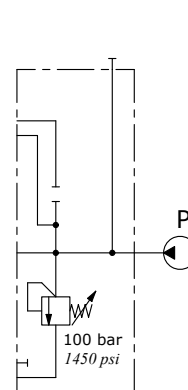

Description example:  
**BC(X-100)**

For right inlet directional valve, upper port

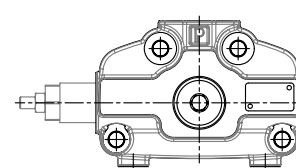
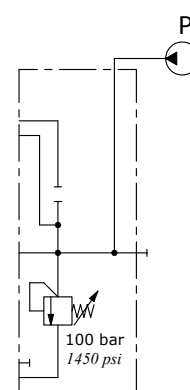

Description example:  
**BD(X-100)**